

Via Weather Series

Designed to withstand
Water & Dust,
& sealed for infection control.

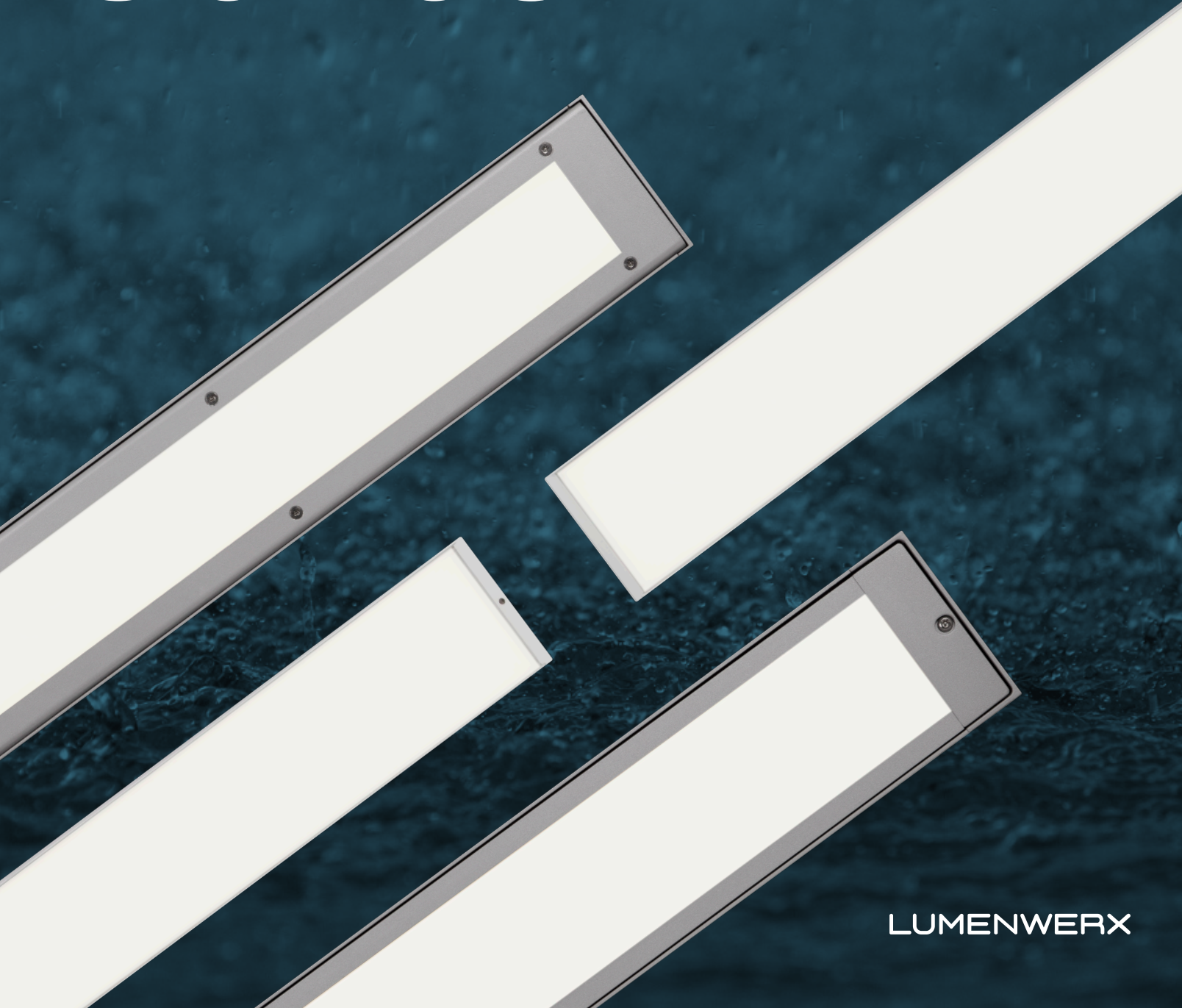

LUMENWERX

Designed for challenging spaces

NEW

Via Seal (Via 2 Seal, Via 3 Seal, Via 4 Seal)

Wet Suitable (IP44) & Wet Listed (IP54)



- Wet Suitable (IP44) or Wet Listed (IP54) options
- Great for outdoors, mullion mount, and indoor wipe-down applications
- Maintains sleek and modern esthetic of our Via family
- Continuous line of light
- Lit corners and patterns available
- Five optics to choose from
- Water & Dust protected
- Fixture and driver are gasketed to protect the electrical components
- The circuit boards are coated with an insulative layer defending against moisture, salt, chemicals and temperature changes
- Not suitable for extreme weather applications



PoE

bios

Bios



SOLA



DUO



QUADRO

Consult specification sheet for available technologies per family

Meet the Via Weather Series, each of which has been meticulously designed to handle sites that are particularly challenging for different reasons. The series complements and furthers our existing Via offering into a full portfolio of robust, intelligent, linear lighting solutions.

Via Wet

Wet Listed + (IP54)

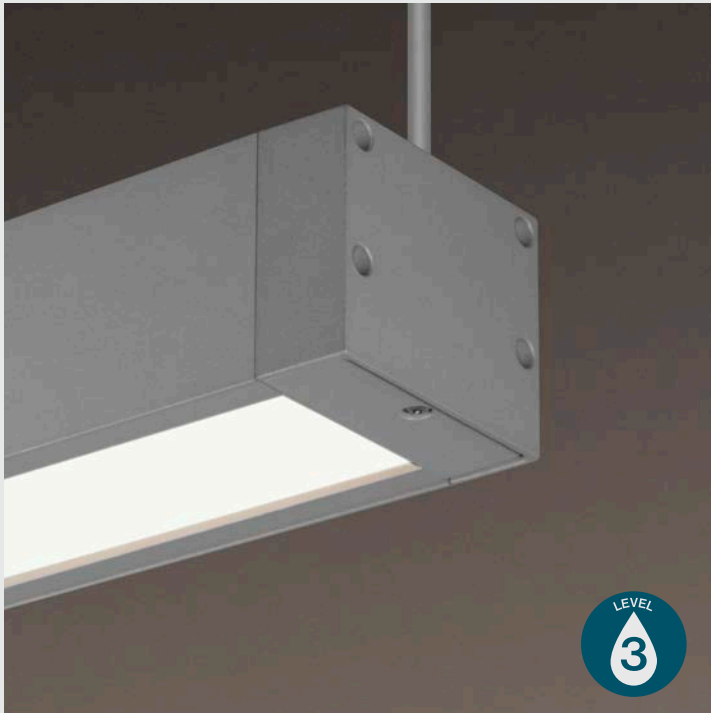

- Wet Listed (IP54)
- Ready for demanding environments
- Outdoor: luminaire can be exposed to the elements
- Indoor application that requires wash down
- Dust-tight
- Fully sealed
- 2-layer gasket and double-lensed
- Smart-Lock Module: Proprietary lens, LED and driver cartridge design

Via Splash

IP66



- IP66-Rated
- Ready for harsh environments
- Outdoor: luminaire can be fully exposed to the elements
- Indoor application that requires high pressure water jet cleaning
- Dust-tight
- Fully sealed, double-lensed unyielding design
- Smart-Lock Module: Proprietary lens, LED and driver cartridge design
- Can be use in industrial, transportation sites and more

Protection Level Guide

Level 1 Wet Suitable (IP44)	Level 2 Wet Listed (IP54)	Level 3 Wet Listed + (IP54)	Level 4 IP66
Via 2 Seal Via 3 Seal Via 4 Seal	Via 3 Seal Via 4 Seal	Via Wet	Via Splash

Via Seal

Wet Suitable (IP44) & Wet Listed (IP54)

NEW

Via Seal maintains the elegant architectural esthetic and flexible control options of our classic Via luminaires, while offering added protection against the elements of nature. With our Environmentally Protected Optics (EPDO, EPIO), Via Seal blocks dust and moisture, resists UV distortion, and withstands moderate impact.

Products

Via 2 Seal, Via 3 Seal, Via 4 Seal

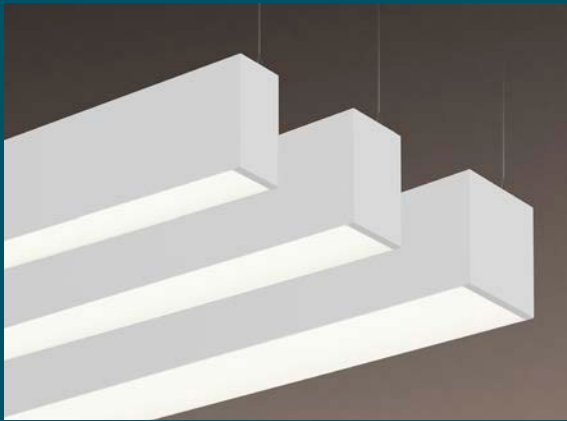

Performance

Up to 2000 lm/ft

Distribution



Direct



Direct/
Indirect*



Indirect**

Mounting options



Pendant



Wall



Recessed



Surface

Lit Corner

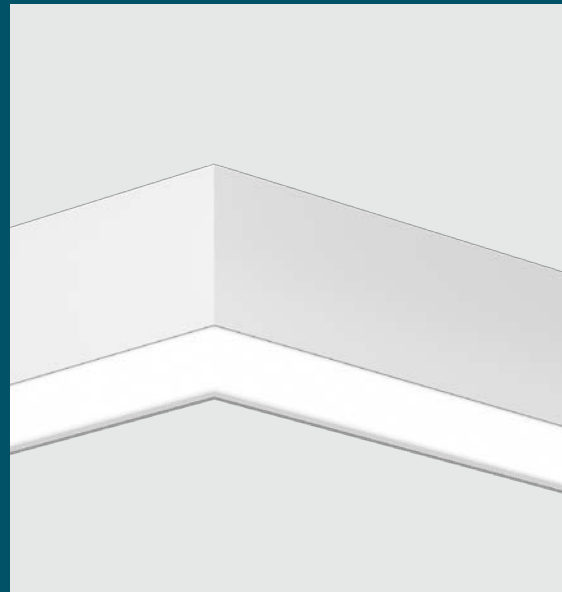

* Offered with Via Seal Wet Suitable option only

** Via 3 Seal only

Strong defense against the elements



- **Three sizes:** Via 2 Seal, Via 3 Seal and Via 4 Seal
- **Maintains sleek and modern esthetic** of our Via family in a fully sealed fixture!
- **Continuous line of light**
- **Great for outdoors, mullion mount,** and indoor wipe-down applications
- **Five optics to choose from**
- **Lit corners and patterns available**

Via Seal

Optical Flexibility

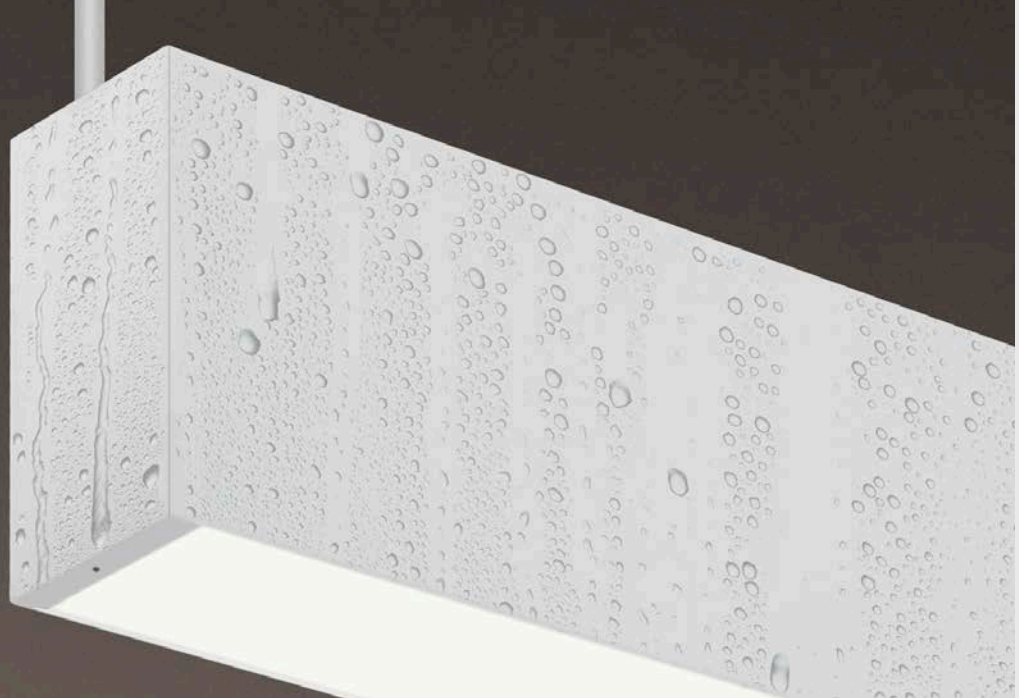

Direct distributions

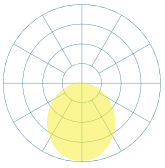

Environmentally Protected Direct Optic (EPDO)

The Environmentally Protected Direct Optic creates a seal that blocks debris and moisture, and withstands UV distortion and moderate impact. This extruded snap-in lens has a gasket to ensure proper sealing.

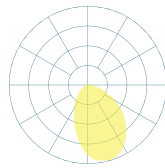

Asymmetric Soft Direct Optic (ASDO)

The Asymmetric Soft Direct Soft Optic, is designed to guide the light through the lens to create a nice asymmetric distribution. This extruded snap-in lens has a gasket to ensure proper sealing that blocks debris and moisture, and withstands UV distortion and moderate impact.



Indirect distributions

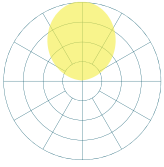

Environmentally Protected Indirect Optic (EPIO)

The Environmentally Protected Indirect Optic creates a seal that blocks debris and moisture, and withstands UV distortion and moderate impact. This extruded snap-in lens has a gasket to ensure proper sealing.

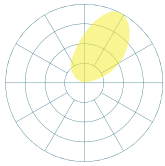

Asymmetric Soft Indirect Optic (ASIO)

The Asymmetric Soft Indirect Soft Optic, is designed to guide the light through the lens to create a nice asymmetric distribution. This extruded snap-in lens has a gasket to ensure proper sealing that blocks debris and moisture, and withstands UV distortion and moderate impact.

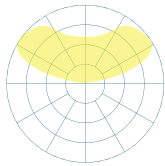

Widespread Indirect Optic (WIO2)

The Widespread Indirect Optic produces noticeably smoother ceiling brightness than a typical lambertian upright distribution, permitting generally wider spacing as well.



Via Seal

Built to withstand the outdoors

Ideal for mullion mounting



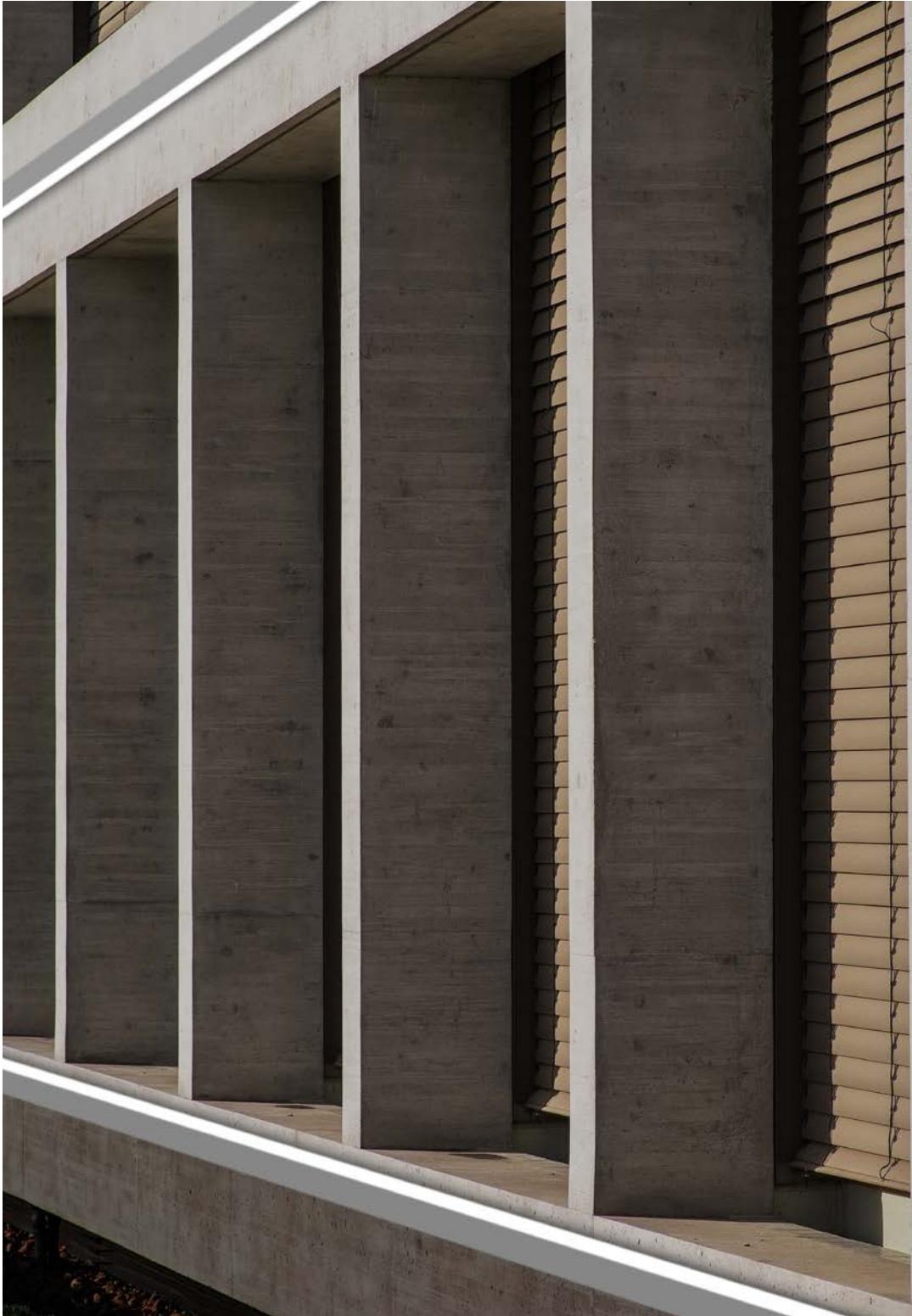

Via 4 Seal
Mullion mounting application

Via Seal Construction

Wet Suitable (IP44) & Wet Listed (IP54)

Via Seal is engineered to defend itself, armed with Environmentally Protected Optics (EPDO, EPIO) that block dust and water intrusion, come with a UV protective layer, and absorb moderate impact. The Via Seal driver is located strategically in the enclosure to protect the electrical components and wiring from contact with moisture, while the circuit boards are coated with an insulative layer that further safeguards against humidity, salt, chemicals, and temperature changes.

Dimensions

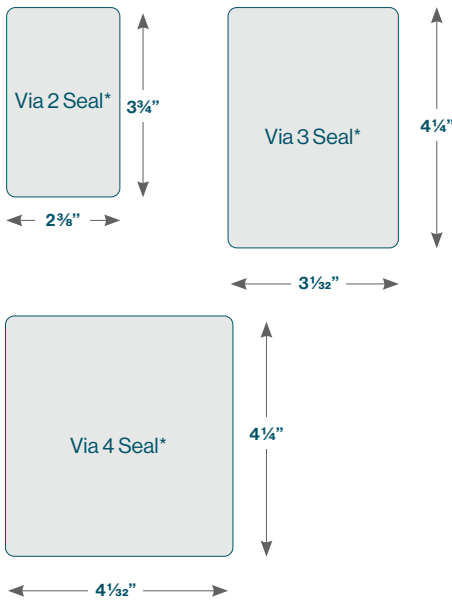

*Direct option

Gasketing & Coating

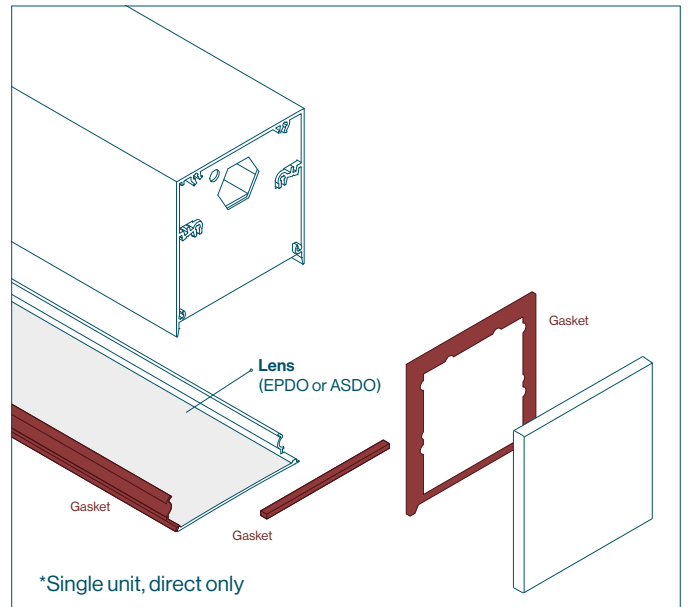

Fixture and driver are gasketed to protect electrical components from water.

The circuit board is coated for added protection.

Joining system

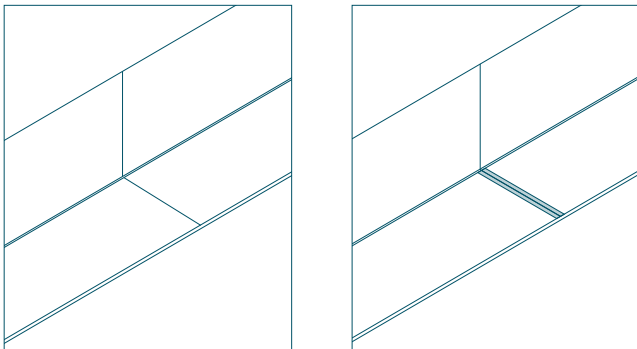

Wet Suitable (IP44)
Continuous line of light

Wet Listed (IP54)
Minimal shadow at junction of joining system due to gasketing

Direct/Indirect End Cap design



Proprietary water expulsion design path within the end cap in the Via Seal Wet Suitable direct/indirect

Moisture expulsion through the **Weeping Hole**

**Continuous
lines
of light**



Fully sealed luminaire
with optional **RGBW**
up light.

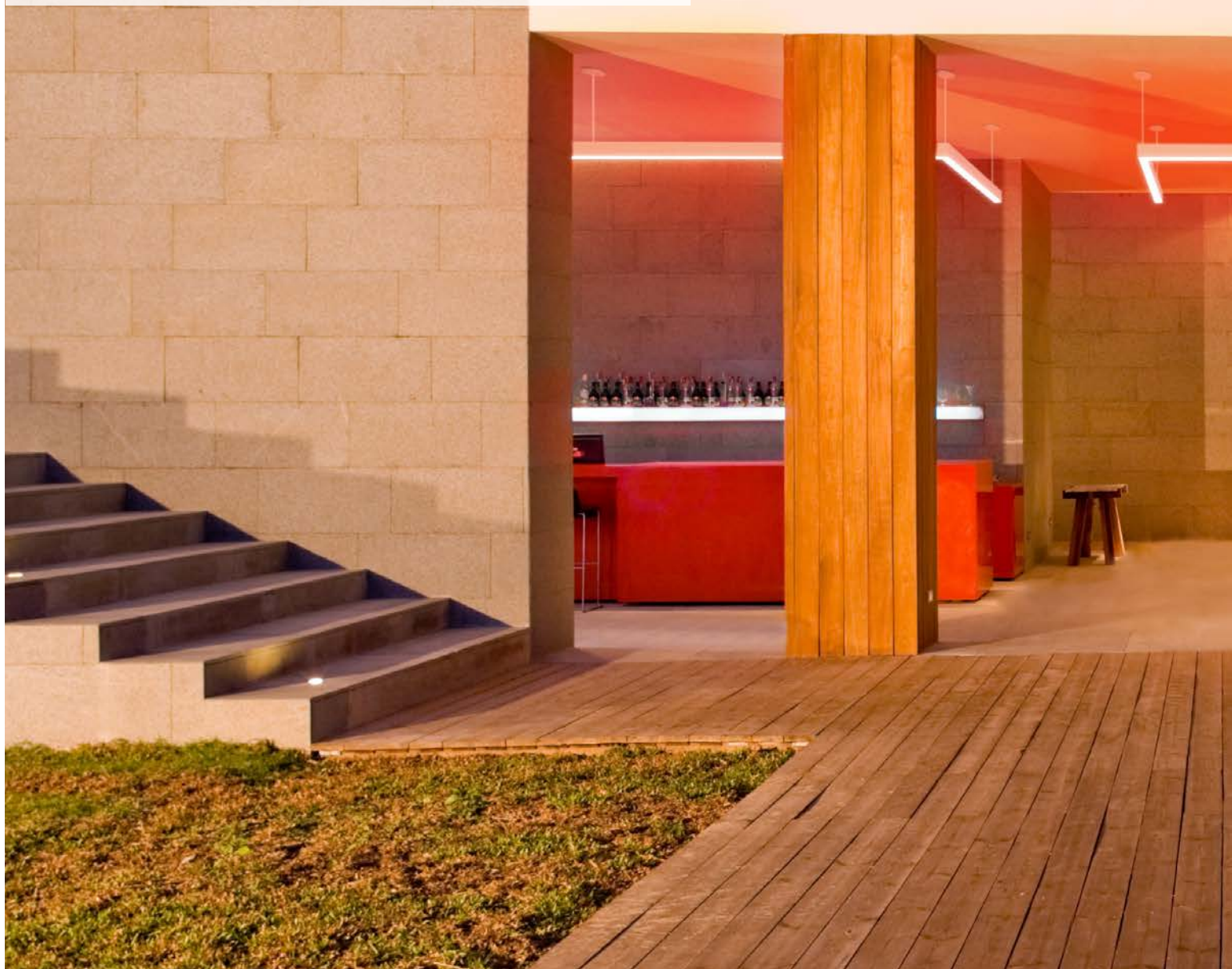

Via 2 Seal, Wet Suitable, Direct/Indirect with:
Environmentally Protected Direct Optic (EPDO) in static white
Environmentally Protected Indirect Optic (EPIO) in RGBW



Via Wet

Wet Listed+ (IP54)

Via Wet is not only equipped with an additional lens layer in either polycarbonate or tempered glass, but it also has a double seal in the form of a two-tiered gasket to ensure that nothing can enter the fixture. Its water-tight and dust-tight durable craftsmanship make it suitable for many harsh environments prone to excessive water and debris. The 4.5-inch profile is available with a natorium and corrosion resistant finish for extra protection. Via Wet can be used outdoors in parking lots, bridges, and exterior trusses, as well as indoors, for example, in pools, food prep areas, and laboratories that undergo frequent wash downs.

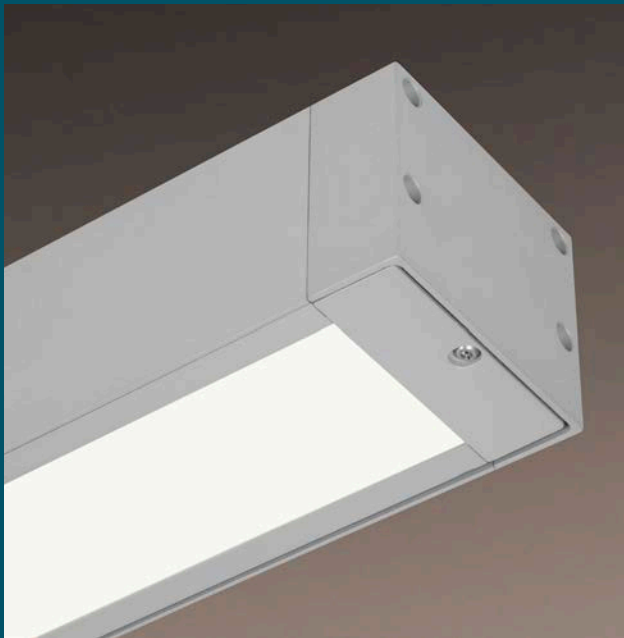

Performance*

Up to 1000 lm/ft

Distribution



Direct

Mounting options



Pendant



Wall



Recessed



Surface

Photometrics

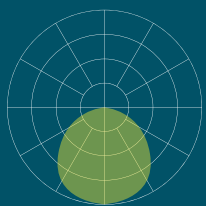

HLO

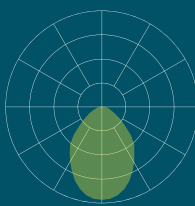

PMO

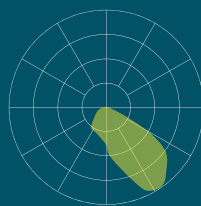

ASYP

Protective Lens

Clear tempered glass (TMO)
UV-protected polycarbonate (PYC)

Direct optics

High-Efficiency Lambertian Optic (HLO)
Precision Micro Optic (PMO)
Asymmetric (ASYP)

Ready for demanding environments



- **Fully** sealed and protected (IP54)
- **Featuring Smart-Lock Module:** proprietary lens, LED and driver cartridge design
- **Corrosion-resistant finish** option for harsh environments (salt, dust & chemical resistant)



Via Wet: Smart-Lock Module*

Proprietary lens, LED and driver cartridge design fully enclosed meeting IP54 criteria for wash down. The Smart-Lock Module can also be easily removed for maintenance without having to remove the entire fixture

* Also featured in Via Splash (see p. 19)

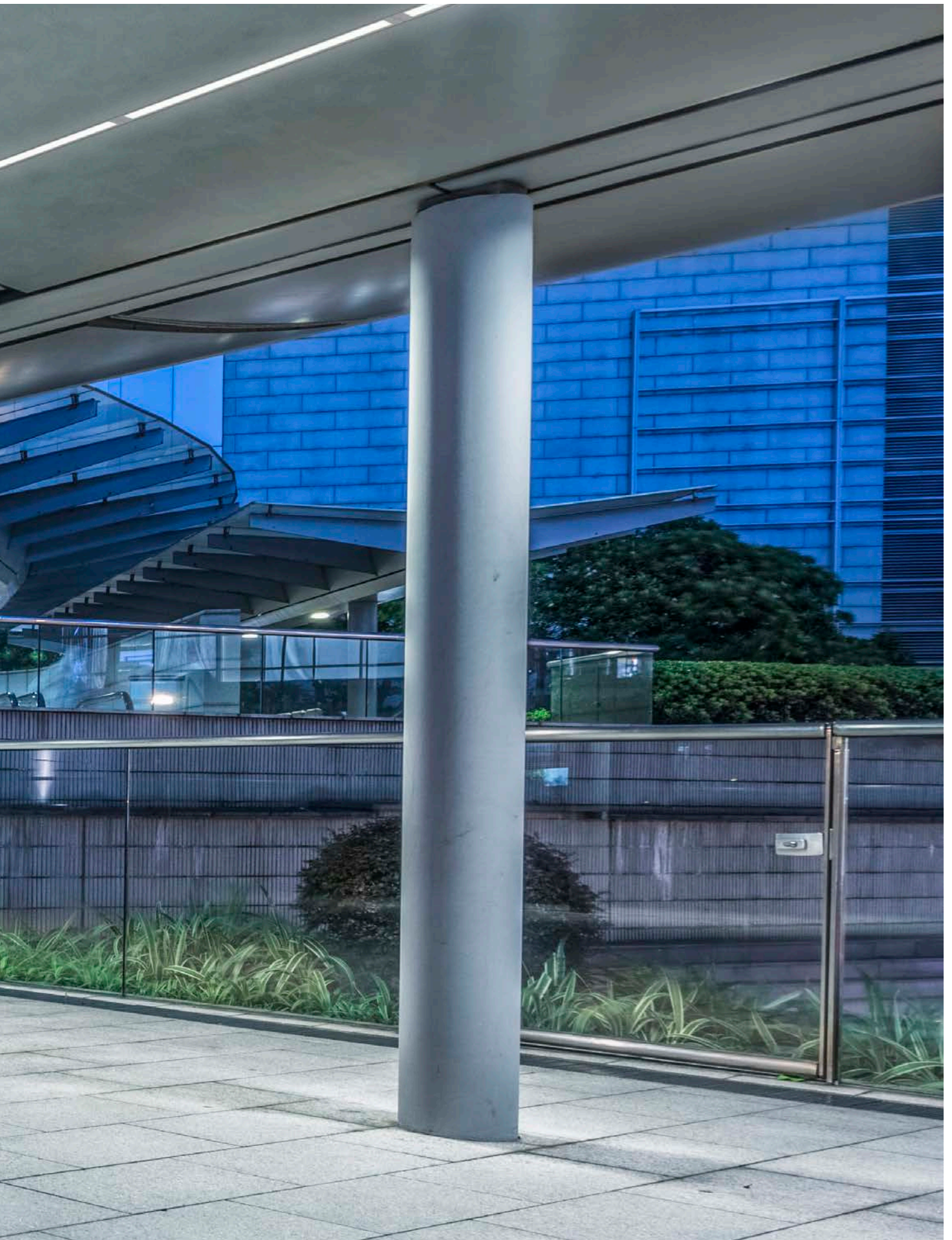

Via Wet Construction

Via Wet is a sturdy luminaire, with two layers of gaskets to block the unwanted intrusion of moisture and fragments. It is intelligently crafted with a Smart-Lock Module that encloses the lensing and electrical components as a discrete unit that can be taken out for maintenance without having to remove the luminaire.

- Fully sealed (IP54) with Smart-Lock Module
- Double-lensed with a choice of tempered glass (TMO) or polycarbonate lens (PYC)
- The luminaire is made up of 3 and 4 foot sections in combination to suit the required length
- Suitable for extreme weather conditions, from -20°C/-4°F to 40°C/104°F

Dimensions

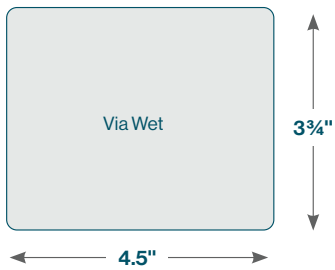

Joining system

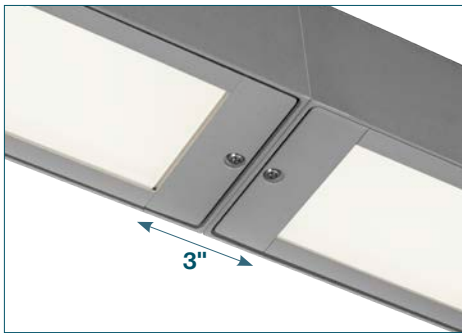

Junction of joining system
Visible break between lens sections.

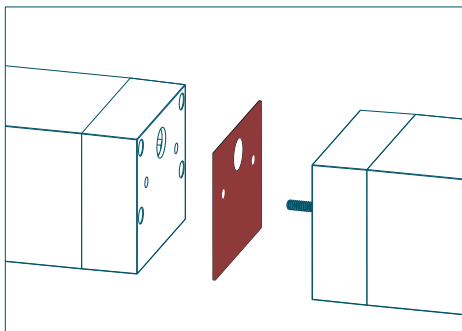

Sealed for continuous run Two adjacent individual sections are sealed by a silicone gasket attached to one of the two sections.

Housing





Engineered for
wash down
environments

Via Splash

IP66

Via Splash offers the most solid defense among the Via Specialists. IP66-Rated, the luminaire is dust-tight and fully protected against powerful jets of water from any direction. Its reinforced lensing and unyielding impenetrable gaskets make the intrusion of any foreign particles virtually impossible. Via Splash has a 5-inch profile, which offers extra protection in exterior environments exposed to the elements and can be used in industrial contexts as well.

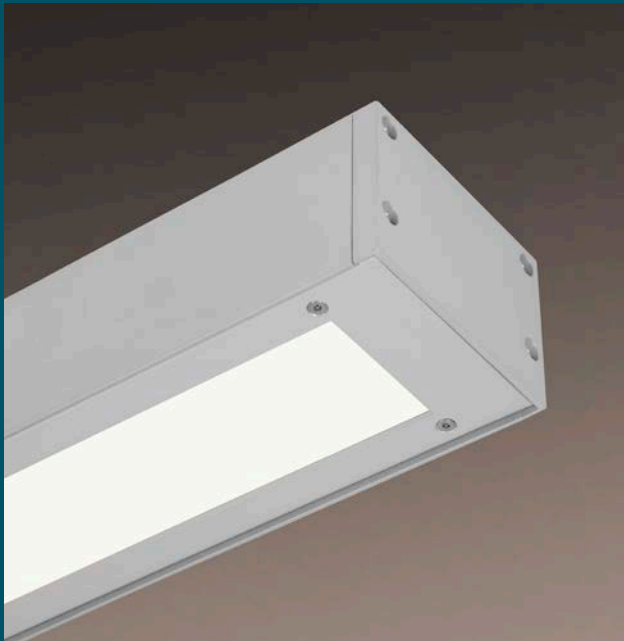

Performance*

Up to 2000 lm/ft

Distribution



Direct



Direct/
Indirect*

Mounting options



Pendant



Wall



Recessed



Surface

Photometrics

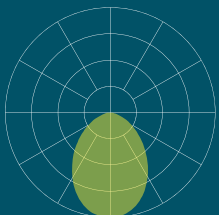

HLO

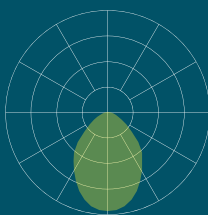

PMO

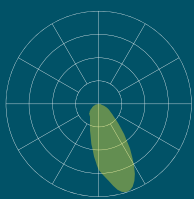

ASYP

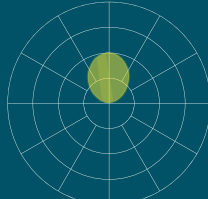

HLO Indirect

Direct Optics

High-Efficiency Lambertian Optic (HLO)

Precision Micro Optic (PMO)

Asymmetric (ASYP)

Indirect Optics

High-Efficiency Lambertian Optic (HLO)

Protective Lens

Clear tempered glass (TMO)

UV-stabilized polycarbonate (PYC)

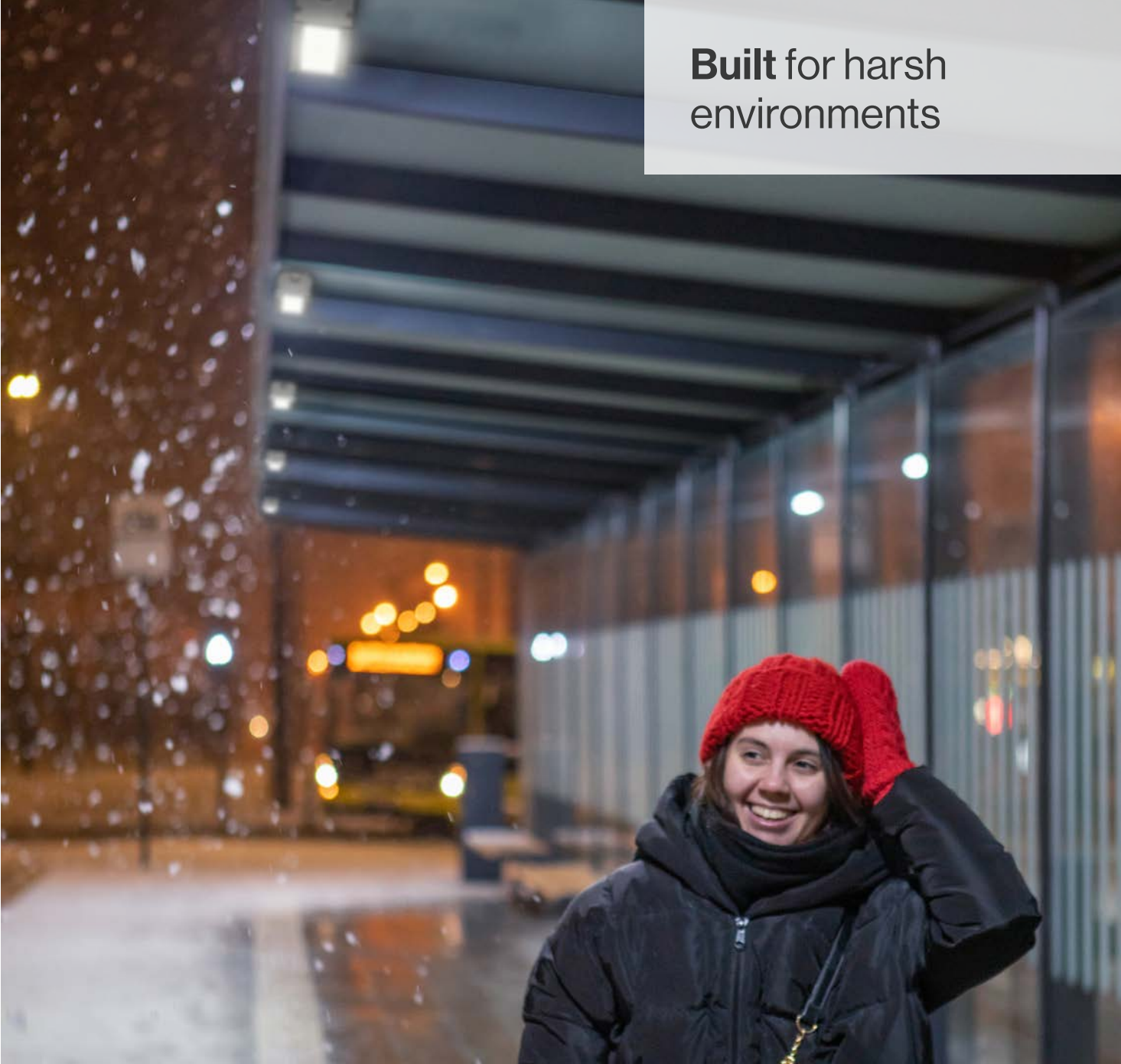

Built for harsh environments

- Fixture can be **fully exposed**
- **IP66**-Rated, double-lensed unyielding design
- Direct/Indirect option
- **Horizontal** and **vertical** application
- **Featuring Smart-Lock Module:** proprietary lens, LED and driver cartridge design
- Can **withstand high-pressure water jet cleaning**

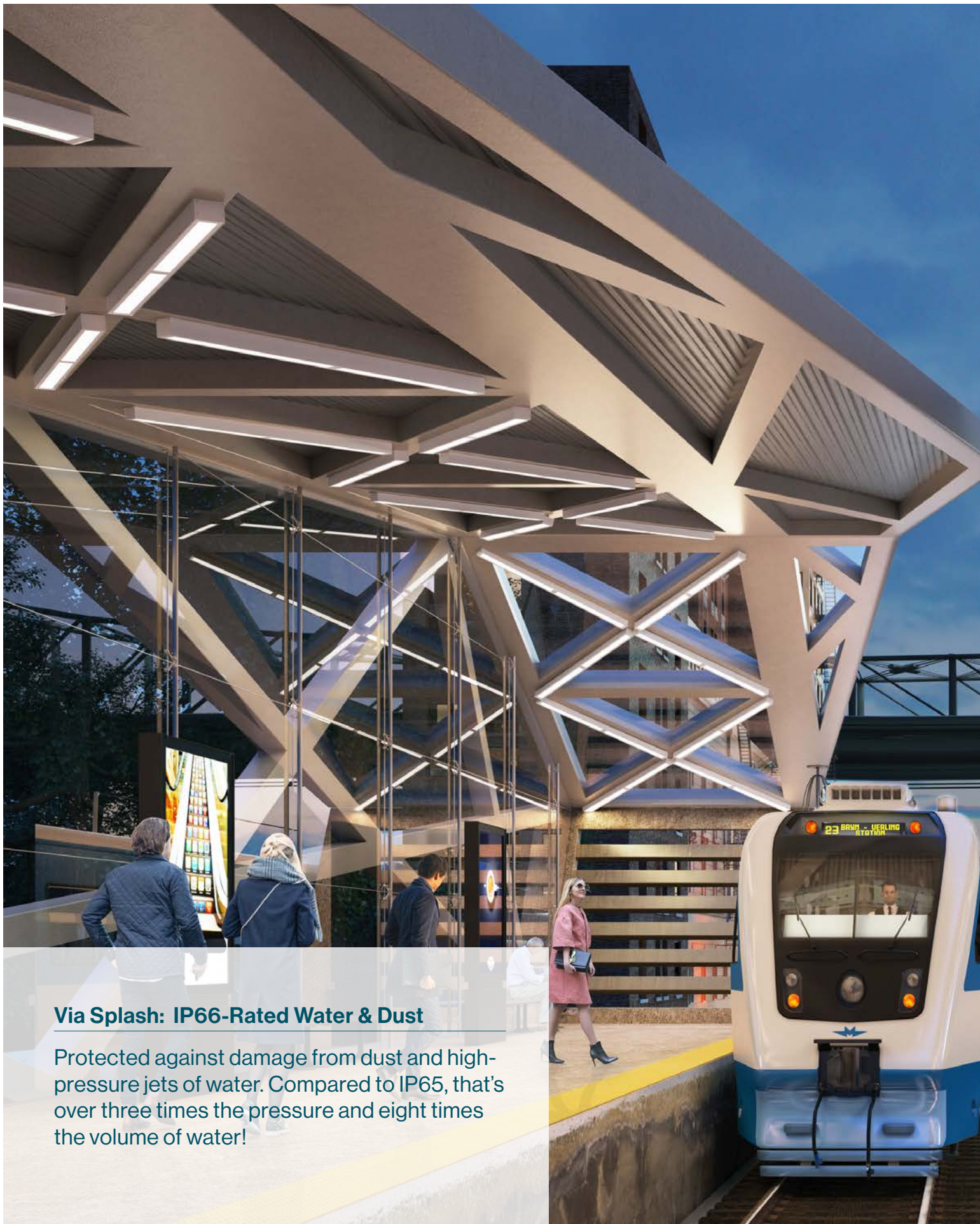

Via Splash: IP66-Rated Water & Dust

Protected against damage from dust and high-pressure jets of water. Compared to IP65, that's over three times the pressure and eight times the volume of water!

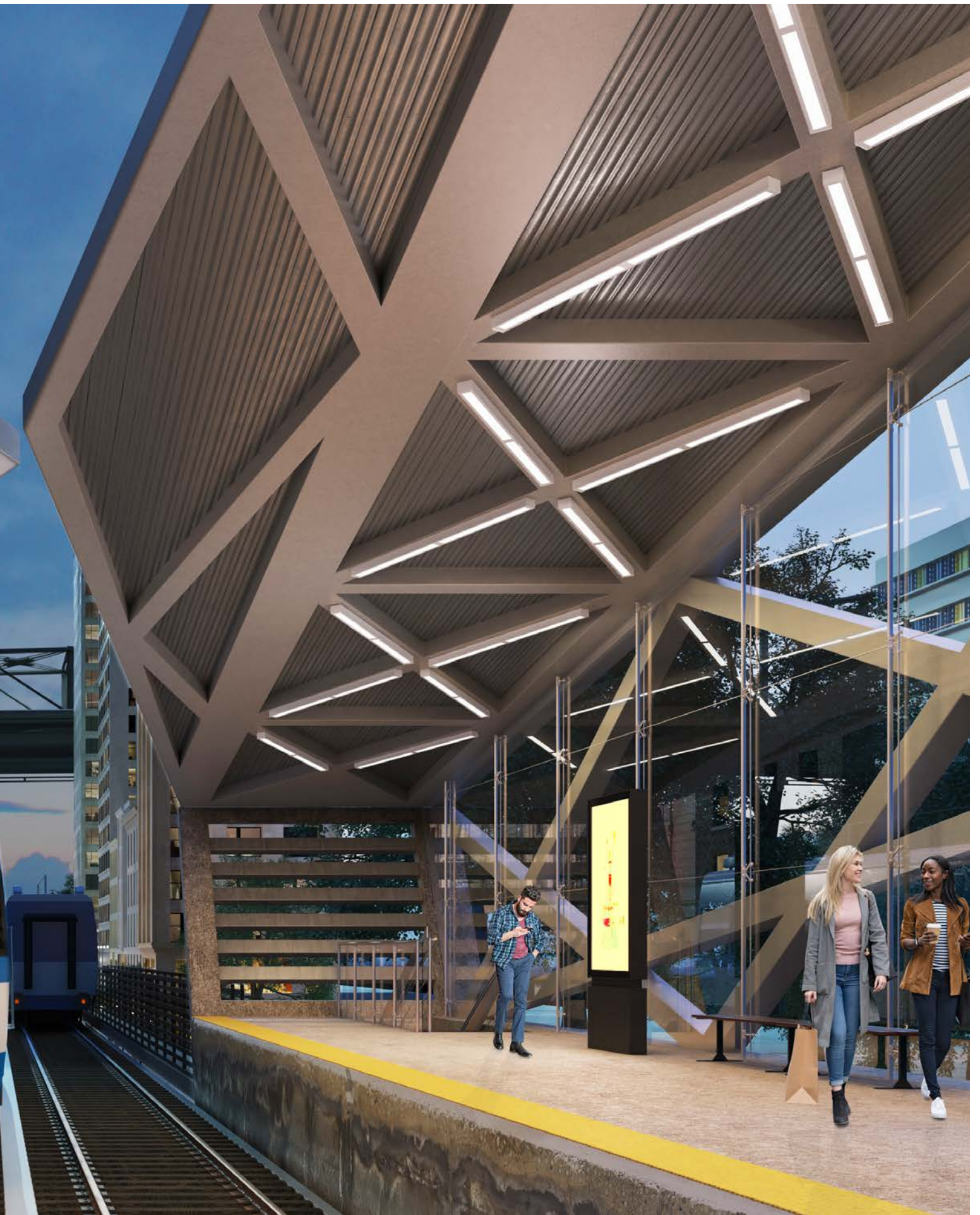

Via Splash Construction

Via Splash features a robust luminaire, with heavy duty gaskets to block the unwanted intrusion of moisture and fragments. It is IP66-Rated. Similar to Via Wet, Via Splash also offers the Smart-Lock Module that encloses the lensing and electrical components as a discrete unit that can easily be taken out for maintenance without having to remove the luminaire.

- Fully sealed with Smart-Lock Module and IP66-Rated
- Double-lensed with a choice of polycarbonate lens or tempered glass
- The luminaire is made up of 3 and 4 foot sections in combination to suit the required length
- Suitable for extreme weather conditions, from -20°C/-4°F to 40°C/104°F

Dimensions

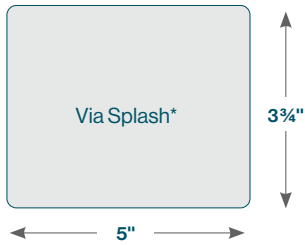

*Direct option

Joining system

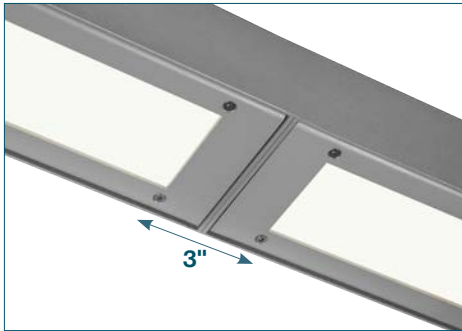

Junction of joining system

Visible break between lens sections.

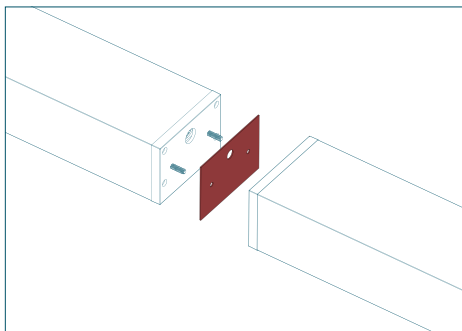

Sealed for continuous run Two adjacent individual sections are sealed by a silicone gasket attached to one of the two sections.

Double lens and Smart-Lock Module



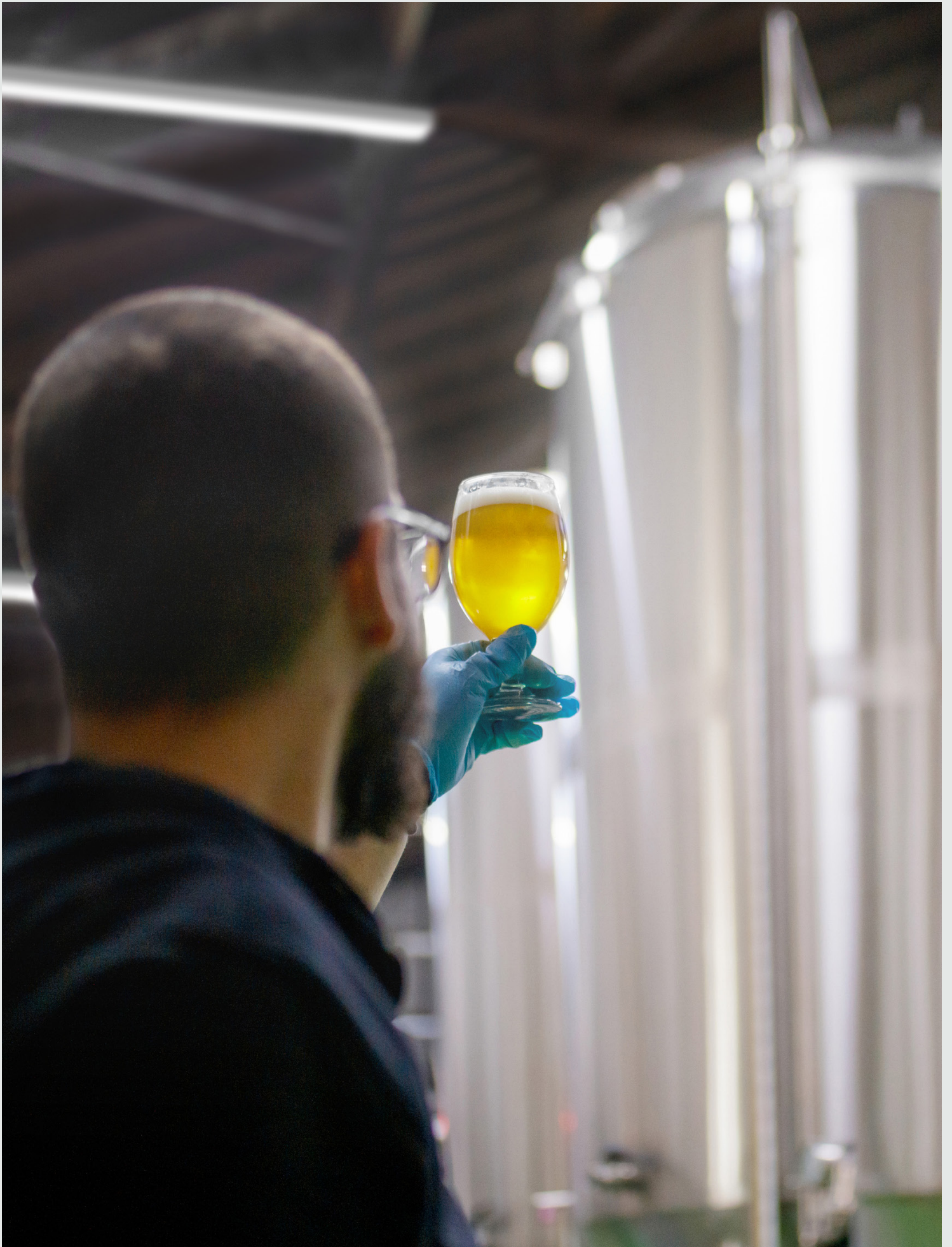

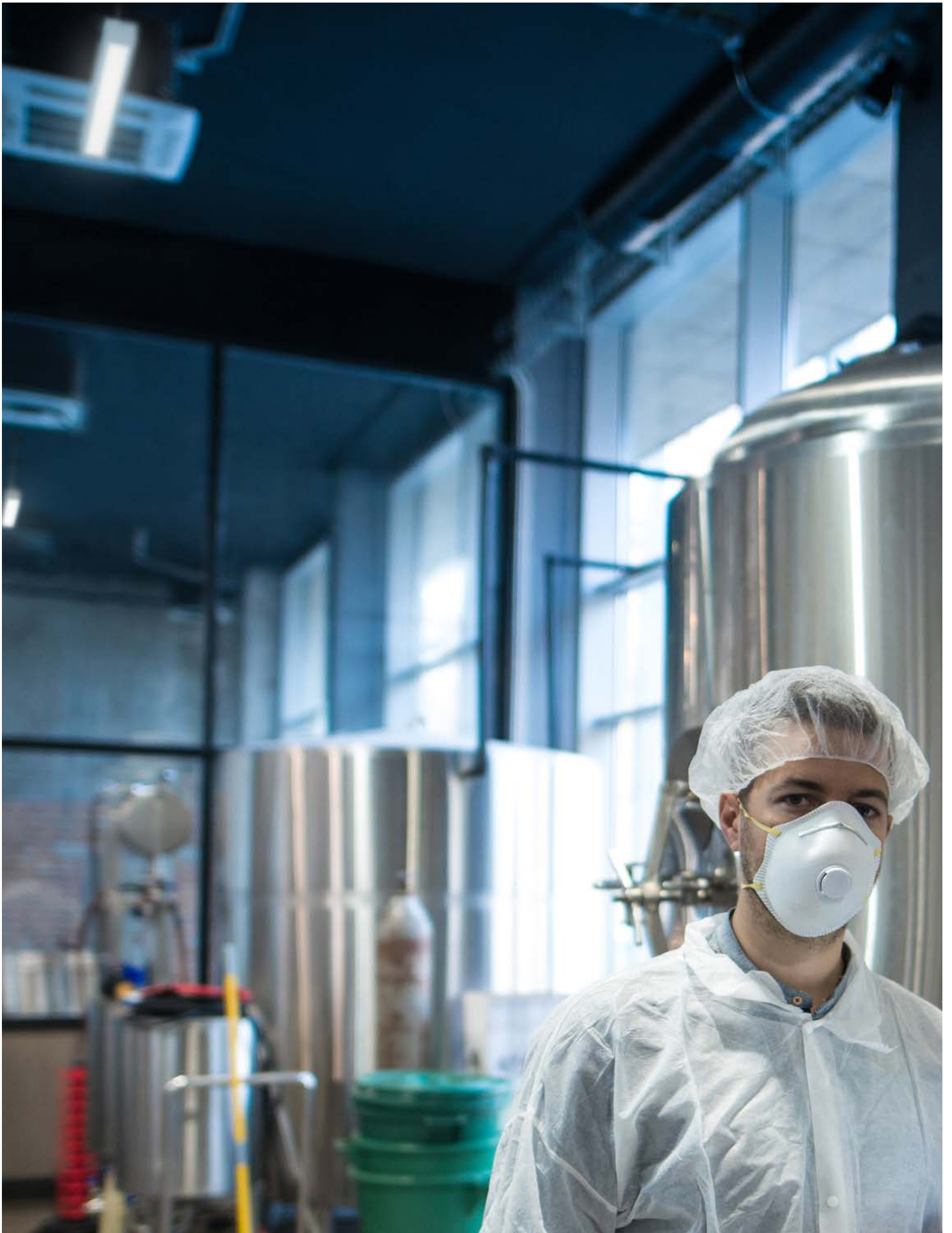

Our Via Weather Series — Via Seal, Via Wet, and Via Splash — maintains the aesthetic sophistication of our Via family, while offering four varying levels of sealing protection that address moisture, dust, and infection control.

The series offers four levels of protective sealing.



Level 1

Wet Suitable (IP44)

Via 2 Seal, Via 3 Seal & Via 4 Seal



Level 2

Wet Listed (IP54)

Via 3 Seal & Via 4 Seal



Level 3

Wet Listed + (IP54)

Via Wet



Level 4

IP66

Via Splash

Explore our indoor solutions with an added seal of protection

Lumenwerx offers additional products that can be sealed for specific applications and to address moisture, dust, and infection control. From sealed troffers with low UGR to Wet Listed downlights to decorative fixtures, at Lumenwerx, we continue to evolve and innovate as your one-stop-shop for the best architectural lighting solutions.

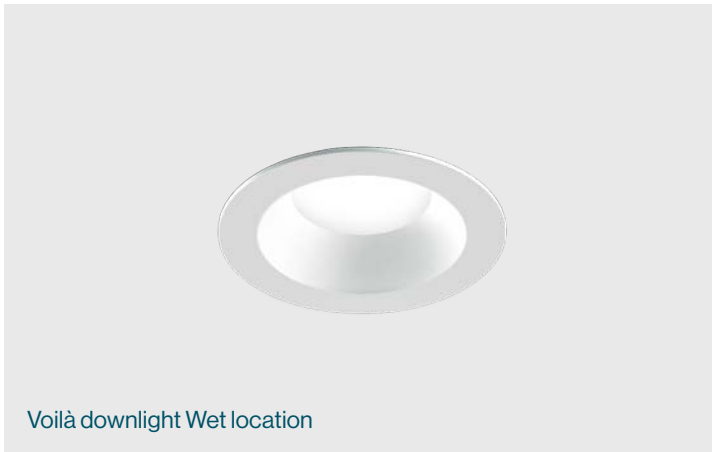

Voilà downlight Wet location



Pop Recessed

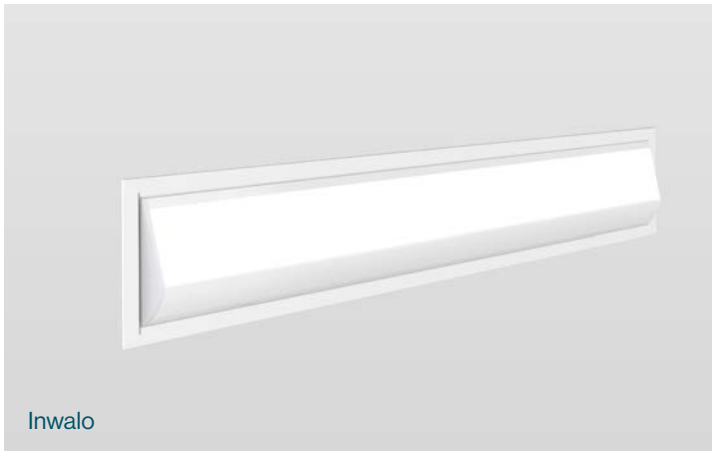

Inwalo



Rim family



Primo



Coming soon

Via Seal Perimeter



Cura



Rize

LUMENWERX

Via Weather Series

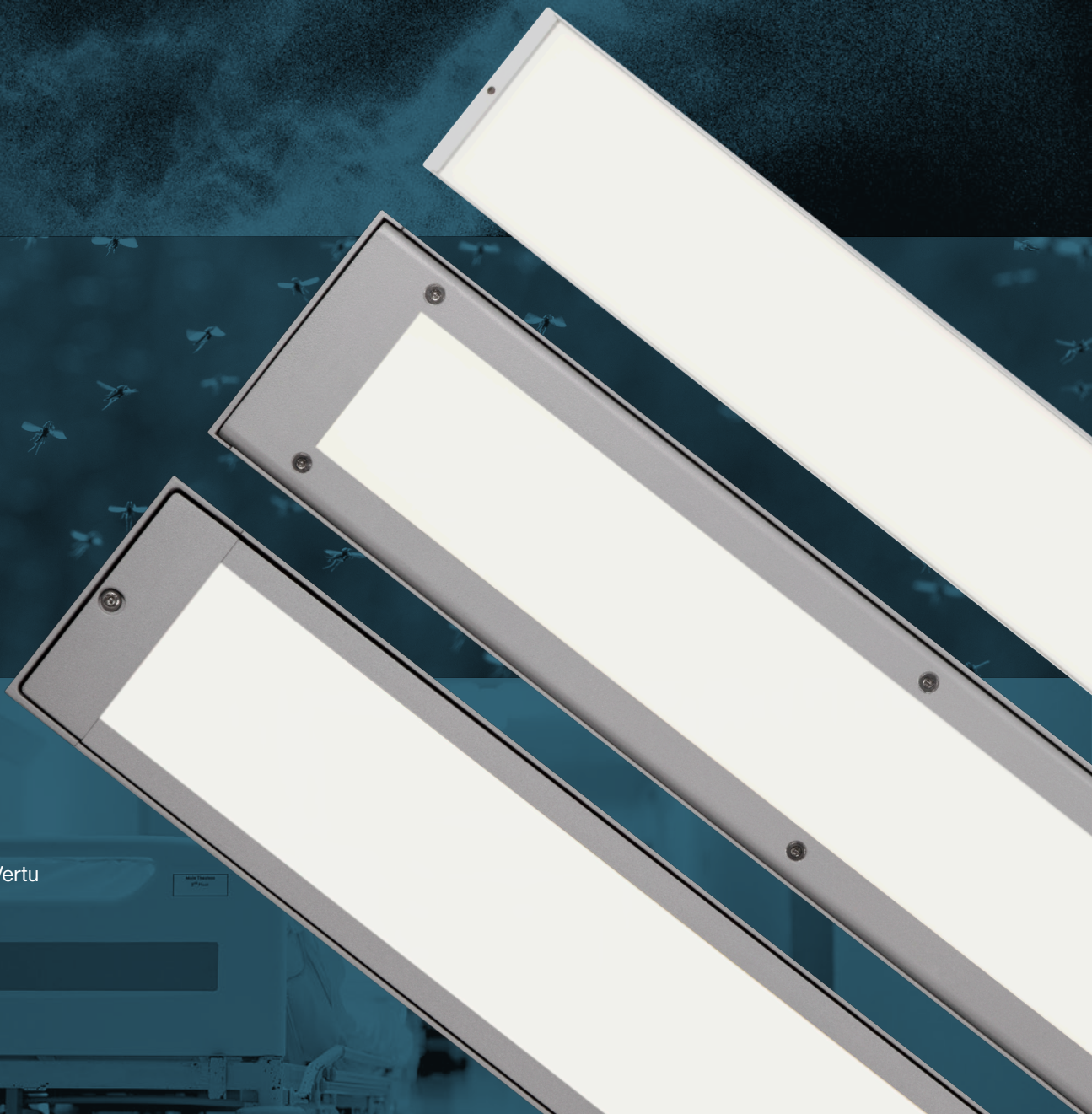

Lumenwerx

3737 boul. de la Côte-Vertu
Saint-Laurent, QC
H4R 2C9

lumenwerx.com

T.: 514.225.4304

F.: 514.931.4862